

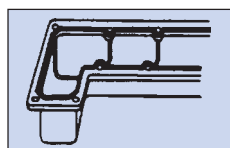

Silicone

for sealing, bonding,
insulating and casting

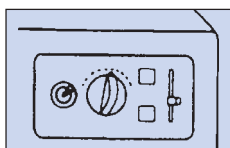

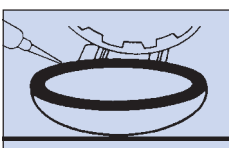
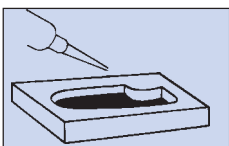

RTV Silicone

WEICON Silicone is a one-component sealant/adhesive which has been developed to meet the high demands of industrial fabrication.

It consists of 100% solid material which cures at room-temperature practically without shrinkage.

It is particularly suitable for use in

- production, construction, maintenance and for quick assembly / repair work.



WEICON Silicone is highly recommended for

- elastic bondings
- coatings
- insulation
- impregnation.

The high dielectric strength makes it ideal for use in electrical engineering and for insulating electrical leads.

Other applications are in making

- seals of any size
- models
- moulds and prototypes

Almost any materials can be joined to themselves and among each other. WEICON Silicone adheres to most surfaces, e.g.

- aluminium, nonferrous metals and steel
- glass, glass cloth and ceramics
- duro- and thermoplastics
- wood and many other materials.

WEICON Silicone is compression-proof and resistant to many aggressive media, such as

- oil and fuel
- fresh and salt water
- industrial waste gas
- diluted acids and salts
- detergents and fruit acids.

WEICON Silicone is non-ageing and adheres without embrittlement or hardening even under changing temperatures. WEICON offers different types of Silicone to cover a variety of applications.

WEICON Silicone N

- neutrally-vulcanizing -

Bonds almost all materials together or to one another, insulates and adheres to substrates such as

- aluminium
- steel and non-ferrous metals
- glass and glass fabrics
- ceramics and wood
- PVC and other plastics

The neutrally-vulcanizing Silicone N is especially suitable to bond polycarbonate and plexiglass. However, environmental stress cracking might be possible depending on the composition of the material to be bonded. Own tests are therefore recommended.

Packaging: cartridges of 310 ml.

WEICON Silicone F

- liquid, self-levelling -

- acetate cross-linking -

Suitable for elastic bonding, insulation and impregnation in industrial use.

Also recommended for sealing and casting to technical components.

The sealing gap should not exceed 10 mm. Silicone F bonds almost all materials to themselves or among each other, insulates and adheres to substrates such as:

- aluminium
- anodized aluminium and steel
- glass and glass fabrics
- ceramics and wood

Packaging: cartridges of 310 ml.

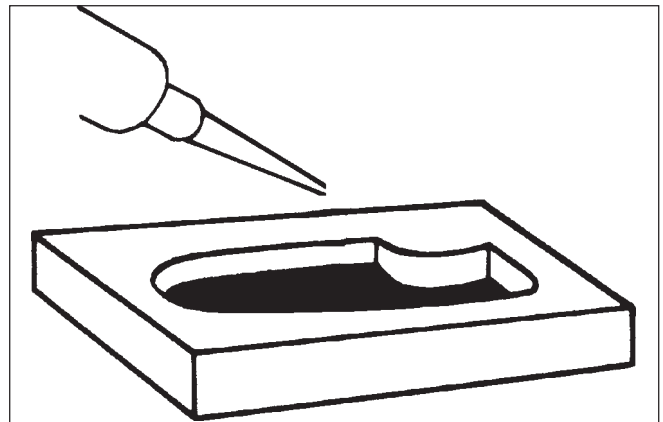

WEICON RTV Silicone

- acetate cross-linking -

The standard type is resistant to temperatures from -40°C to +180°C (briefly up to +260°C) and is available in transparent, white, grey, black and aluminium.

Packaging: cartridges of 310 ml, tubes of 85 ml (transparent, white and black).

WEICON Silmate®

- acetate cross-linking -

This special grade is highly suitable for use in

- machine construction and engineering
- engine and car manufacturing

WEICON Silmate® has outstanding resistance to greases, oils and similar substances and is resistant to temperatures from -60°C to +205°C (briefly up to +260°C). Due to these properties, the product offers leakproof bonding/sealing in

- engines and water pumps
- gears and axles
- oil sumps etc.

even under tough operating conditions.

Colour: black.

Packaging: cartridges of 310 ml, tubes of 85 ml.

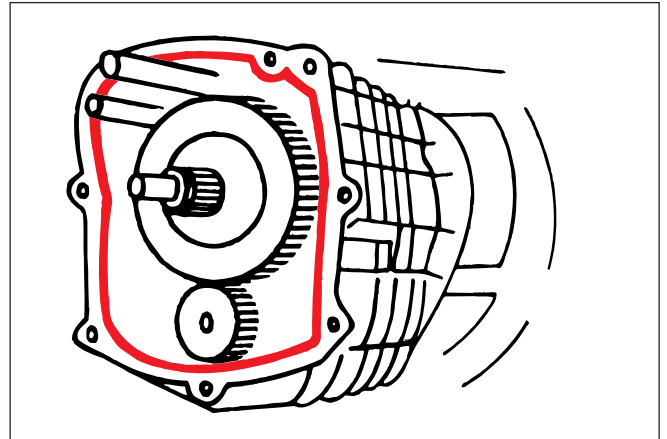

Silmate® = registered trademark of GE SILICONES

WEICON HT 300

- acetate cross-linking -

This product finds its use in high-temperature applications. It withstands permanent exposure to temperatures of +230°C (briefly up to +300°C) and is therefore recommended for use in hot cabinets and ovens (e.g. sealing and fixing inspection glasses).

Colour: red

Packaging: cartridges of 310 ml, tubes of 85 ml.



General physical and technical data

	Silicone	Silicone N	Silicone F	Silmate®	HT 300
Colour	transp., white, black, grey, aluminium	transparent	transparent	black	red
Consistency	putty	putty	liquid	putty	putty
Crosslinking agent	Acetate	Alkoxy	Acetate	Acetate	Acetate
Solvent	none	none	none	none	none
Spec. gravity (kg/dm³)	1,03	1,03	1,03	1,06	1,19
Skin-over-time (minutes)	20	4	15	10	7
Shore-A-Hardness to DIN 53505	16	23	22	35	44
Elongation at break (%) to DIN 53504, S 3 A	600	270**	370	460	300
Tensile strength (N/mm²) to DIN 53504, S 3 A	1,7	0,60**	1,8	3,35	2,1
Tear resistance at 100% to DIN 53504, S 3 A, N/mm²	0,25	0,33**	0,35	--	1,0
Temperature resistance	-40 °C to +180°C briefly up to +260°C	-40°C to +120°C briefly up to +150°C	-40°C to +180°C	-60°C to +205°C briefly up to +260°C	-40°C to +230°C briefly up to +300°C

Shelf life at room temperature: 12 months (WEICON Silicone N: 9 months in unopened cartridge).

**These data are based on DIN 52455 (glass/glass) test

Important note: The specifications and recommendations given in this brochure must not be seen as guaranteed product characteristics. They are based on our laboratory tests and on practical experience. Since individual application conditions are beyond our knowledge, control and responsibility, this information is provided without any obligation. We do guarantee the continuously high quality of our products. However, own adequate laboratory and practical tests to find out if the product in question meets the requested properties are recommended. A claim cannot be derived from them. The user bears the only responsibility for non-appropriate or other than specified applications.

Silicone

for sealing, bonding,
insulating and casting

Distributed by:

Calculation of needed quantity

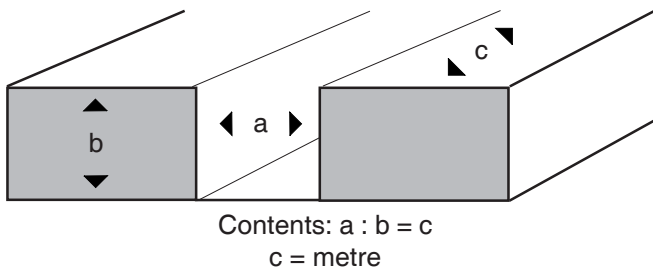

Needed quantity

Depth of joint >	5 mm		6 mm		8 mm		10 mm		12 mm	
	ml/m	m/Cart.	ml/m	m/Cart.	ml/m	m/Cart.	ml/m	m/Cart.	ml/m	m/Cart.
5 mm	25	12,4	30	10,3						
6 mm	30	10,3	36	8,6						
8 mm	40	7,75	48	6,5	64	4,8				
10 mm	50	6,2	60	5,2	80	3,9	100	3,1		
12 mm	60	5,2	72	4,3	96	3,2	119	2,6		
15 mm	75	4,1	90	3,4	120	2,6	148	2,1	182	1,7
18 mm			108	2,9	144	2,2	182	1,7	221	1,4
20 mm					160	1,9	194	1,6	240	1,3
25 mm							258	1,2	300	1,0

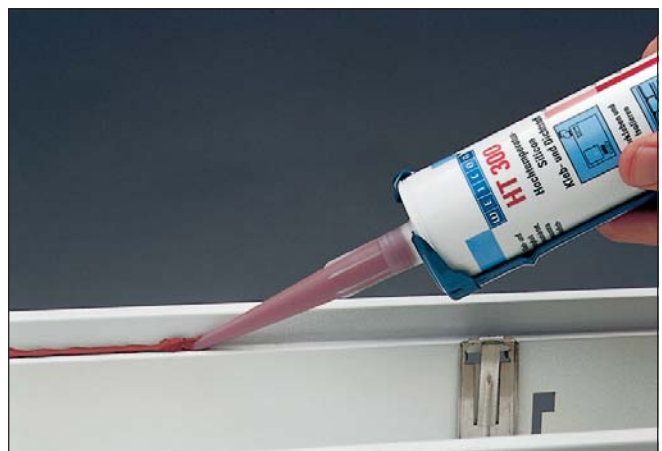

139000113/0410DC